



A Versatile New DC - 500 MC Oscilloscope with High Sensitivity and Dual Channel Display

To -hp- Journal readers:

The accompanying article describes what we believe to be a fundamental breakthrough in the field of high frequency oscilloscopes. The instrument described in the article combines great bandwidth and high sensitivity with basic ease and simplicity of operation. It is in every sense of the word a general purpose instrument. From the user's standpoint it should be evaluated in these terms.

The techniques used to achieve these results are in a sense only incidental; nonetheless much of the article that follows is devoted to a detailed discussion of technique. This is consistent with the Journal policy of presenting a clear technical exposition of significant contributions of the Hewlett-Packard Research and Development groups.

Our experience with this oscilloscope in our own laboratories has been most promis-

ing. In one case, we discovered an important phenomenon which appears to hold great promise for use in the field of instrumentation. Without this high performance oscilloscope, the phenomenon would have gone unnoticed. Our own use for this instrument grows daily. We commend it to you for your consideration as a high-speed, high-sensitivity, simple-to-operate, general-purpose oscilloscope.

—Wm. R. Hewlett

THE illustration below shows a new oscilloscope which greatly extends for the engineer the frequency range over which he can obtain the information that only an oscilloscope can provide. This new oscilloscope is a general-purpose instrument with a frequency response extending up to 500 or more megacycles—i.e., to some four octaves higher than has previously been available in such an instrument. The increase in capabilities extends not only to frequency, however, but also to sensitivity since, if anything, the new oscilloscope has higher sensitivity over its entire range than previous "high frequency" type oscilloscopes have provided over frequency ranges that extended only into the lower megacycle region.

The value of the new oscilloscope as a measuring instrument for fast work can be judged from the fact that its 500-megacycle bandwidth gives it a rise time of 0.7 millimicrosecond. At the same time it has a maximum calibrated sensitivity of 10 millivolts/cm, which is increasable to about 3 millivolts/cm with an uncalibrated vernier. Moreover, these bandwidth and sensitivity characteristics are made available in each channel of a dual-channel plug-in type vertical amplifier. In the millimicrosecond region, the dual-channel provision is probably even more valuable than in the microsecond region because of the generally more difficult problem of time-relating phenomena on a millimicrosecond time scale. Fig. 2, for

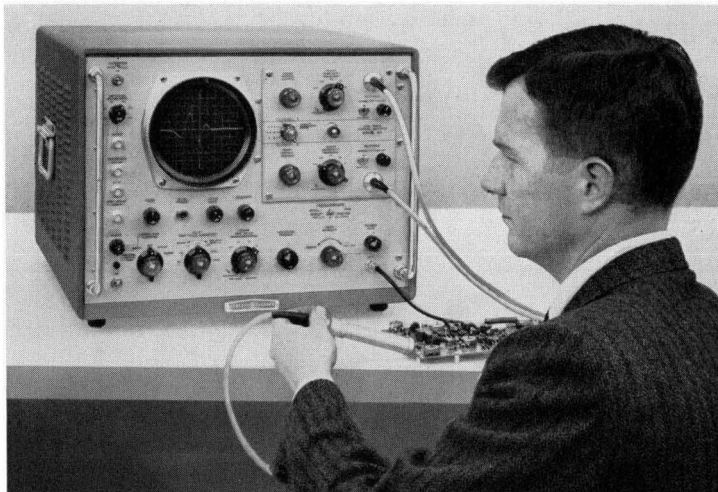

Fig. 1. New -hp- Model 185A/187A Oscilloscope displays signals from 3 millivolts to 2 volts (x10 with adapter) over frequency range up to 500 megacycles. Besides very wide bandwidth and high sensitivity, instrument has several special advantages not found previously in oscilloscopes.

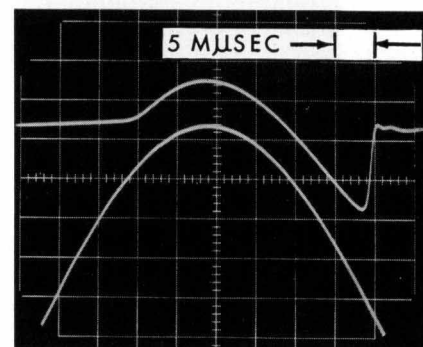

Fig. 2. Oscillogram made from new oscilloscope in which unusual current characteristic observed in semiconductor diode (upper trace) is compared with portion of 10 mc driving voltage (lower trace). Very fast discontinuity in current characteristic is described on p. 3. See also p. 7 for method of making permanent record of displays.

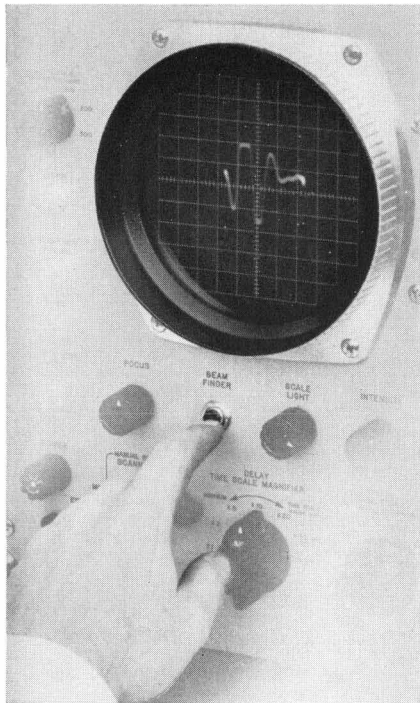

Fig. 3. New "beam-finder" feature enables off-screen trace to be located immediately by pushing panel switch, thus overcoming long-time oscilloscope inconvenience. When switch is depressed, display indicates direction and amount beam is off-center, greatly simplifying adjustment of centering controls.

example, shows how the dual-channel display facilitates relating a fast phenomenon occurring in semiconductor diodes to a driving function.

Other characteristics that describe the degree to which the new oscilloscope has removed previous measurement limitations include the fact that it will trigger from signals with repetition rates higher than 50 megacycles. Calibrated sweeps are provided from 100 millimicroseconds/cm down to 0.1 millimicrosecond/cm, while a calibrated magnifier of up to x100 magnification is provided in combination with a delay control for delayed sweep applications. Both voltage and time calibrators are provided, the time calibrator providing frequencies of 500 and 50 megacycles for check purposes. The instrument has a large signal capacity, being capable of directly displaying signals up to 2 volts peak-to-peak, while accidental application of voltages up to 50 volts directly to the vertical inputs does not cause damage. An adapter increases both of these values by a factor of 10. In its display system, too, the instrument reverses previous trends in that it achieves about twice as much vertical deflection (10 cm) as that found in oscilloscopes an order of mag-

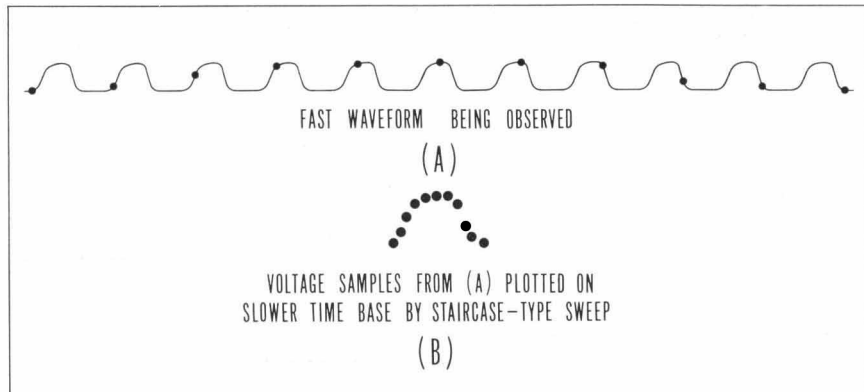

Fig. 4. Drawing indicating technique new oscilloscope uses to "strobe" observed signals. Samples (indicated by circles in (A)) are taken of signal amplitude on successive signal cycles and replotted (B) on slower time-base by staircase sweep voltage.

nitude or more lower in frequency.

The instrument also incorporates a new arrangement for locating the crt beam when it is off-screen. In this arrangement a pushbutton on the panel limits the crt deflection voltages such that an off-screen trace is always brought on-screen and is done so in such a way as to greatly simplify adjusting the positioning controls.

SAMPLING TECHNIQUE

Two singular features of the new instrument are that it provides an output for operating an X-Y recorder and that the brightness of the trace is independent of the repetition rate of the observed signal, remaining as bright with low duty-cycle signals as with high. These characteristics, in addition to the primary advantages of very wide bandwidth and high sensitivity, have been achieved by designing the instrument to make use of a technique—the "sampling" technique—which is the electrical equivalent of the optical stroboscopic principle used in mechanical applications. As employed in the instrument, the sampling technique "ob-

serves" an external waveform by sampling the voltage amplitude of progressive points on successive cycles of the waveform while translating phase information concerning these points to a much slower time base equal to the number of waveform cycles needed to complete the sampling.

Fig. 4 demonstrates how the sampling technique is used to plot a waveform applied to the oscilloscope. During one recurrence of the waveform a sample is taken of the voltage amplitude at some point on the waveform. This sample is a very short pulse whose amplitude is proportional to the amplitude of the waveform at the moment of sampling. On ensuing recurrences, samples are taken at relatively later moments of time on the waveform.

These very short samples are then "stretched" in time into much longer samples which are amplified and applied to the crt as a Y-axis signal. The X-axis waveform, then, instead of being the customary sawtooth, is a staircase waveform which plots each of the Y-axis voltage samples as a discrete point, although the plotting density is high

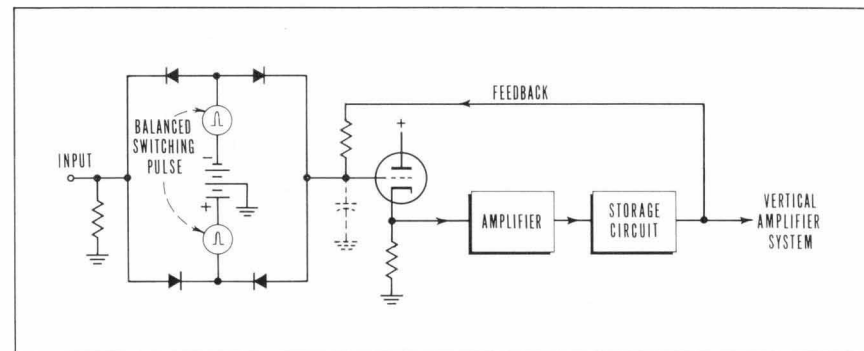

Fig. 5. Basic circuit arrangement of sampling circuitry used in new oscilloscope. Servo-type circuit arrangement causes circuit to supply its own error signal if inaccurate sample should occur, thus making accuracy independent of sampling gate, switch pulse variations or gain variations.

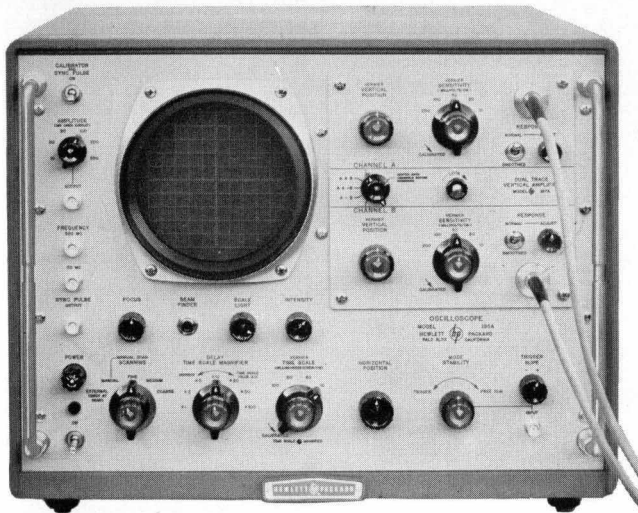

Fig. 6. Panel view of -hp- Model 185A Oscilloscope with Model 187A Dual-Trace plug-in amplifier. Instrument uses new circuit technique, but controls are conventional and include presentation selector for separate or combined - channel displays.

enough so that the overall plot appears continuous. Normally, 1,000 points are plotted per sweep (100 points per centimeter).

The sampling process, then, is a means of trading time for gain-bandwidth. It is one which requires fast cir-

cuits only for the sampling circuits, which are non-amplifying circuits located directly at the instrument input. The voltage samples themselves are translated to a longer time base for convenient amplification and display by conventional circuits. Since each sam-

ple is displayed on the crt until the next sample is taken, the brightness of the display becomes independent of the repetition rate or duty cycle of the waveform.

VOLTAGE ACCURACY INDEPENDENT OF SAMPLING

The particular design evolved for the sampling arrangement has a number of points of special interest both from an engineering and from a usage viewpoint. The sampling circuit itself (Fig. 5) consists of a very fast diode switch located between the input terminal and the input capacity of a cathode follower. Sampling is accomplished by momentarily closing the switch with a submillimicrosecond pulse from the fast pulse generator. This action stores a very short pulse of current proportional to the instantaneous signal amplitude in the cathode follower's input capacity, and the sample becomes the resulting change in voltage that occurs across the capacity during switching. The switch is composed of four

HIGH-SPEED EFFECT IN SOLID-STATE DIODES EXPLAINED WITH NEW OSCILLOSCOPE

One of the first applications of an early model of the new sampling oscilloscope described herein was to investigate a high-speed phenomenon observed in certain junction diodes. In working with diode harmonic generators, using the variation in capacitance of diodes with reverse

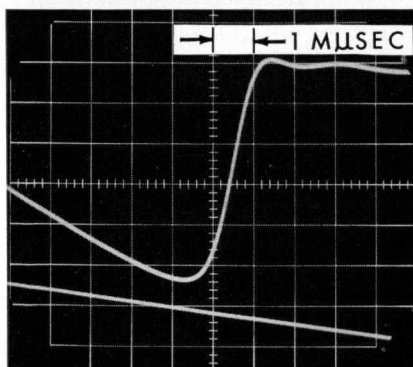
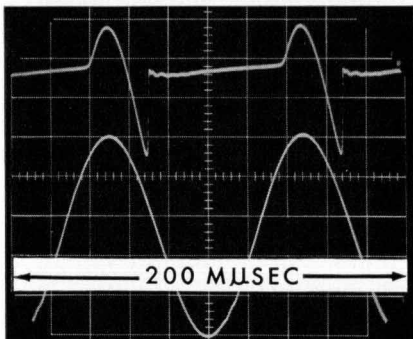

bias as the mechanism of harmonic generation, A. F. Boff of the -hp- laboratories discovered that allowing certain diodes to conduct during a certain portion of the cycle increased the diode conversion efficiency at high harmonics by more than tenfold. Theories brought to bear did not explain the effect or why various diodes differed. Use of conventional oscilloscopes to observe the effect did not provide an answer.

At about this time an early version of the sampling oscilloscope became available and was used to investigate the diode operating in the circuit shown. The oscilloscope revealed the diode current waveform to be as shown in the upper trace of the first oscillogram and provided the key to the mechanism. In the upper portion of the cycle the diode is conducting in the forward direction under the control of the applied voltage (lower trace). When the diode

then becomes reverse-biased, the current reverses, being supplied by minority carriers stored during the forward portion of the cycle. The reverse current builds up to significant proportions, but when the supply of stored carriers is exhausted, the current drops very rapidly to zero. This mechanism would predict that the most effective diodes would have a long storage time and be of the graded junction type, and such has been found to be the case. The second oscillogram shows the phenomenon in greater detail using a sweep time of 1 millimicrosecond/cm. The rise time of the discontinuity is less than a millimicrosecond, showing the effect to be faster than the oscilloscope.

The effect was described in detail in the paper, "A New High-Speed Effect in Solid-State Diodes," given at the 1960 International Solid-State Circuits Conference by A. F. Boff of -hp-, Dr. John Moll of Stanford University and R. Shen of Harvard University.

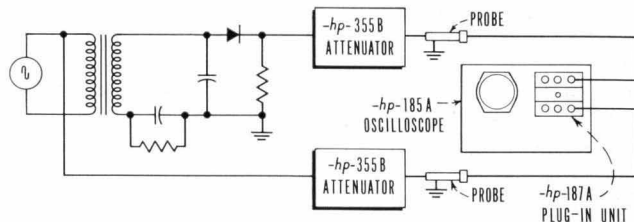

Test circuit used to compare diode characteristic and driving waveform.

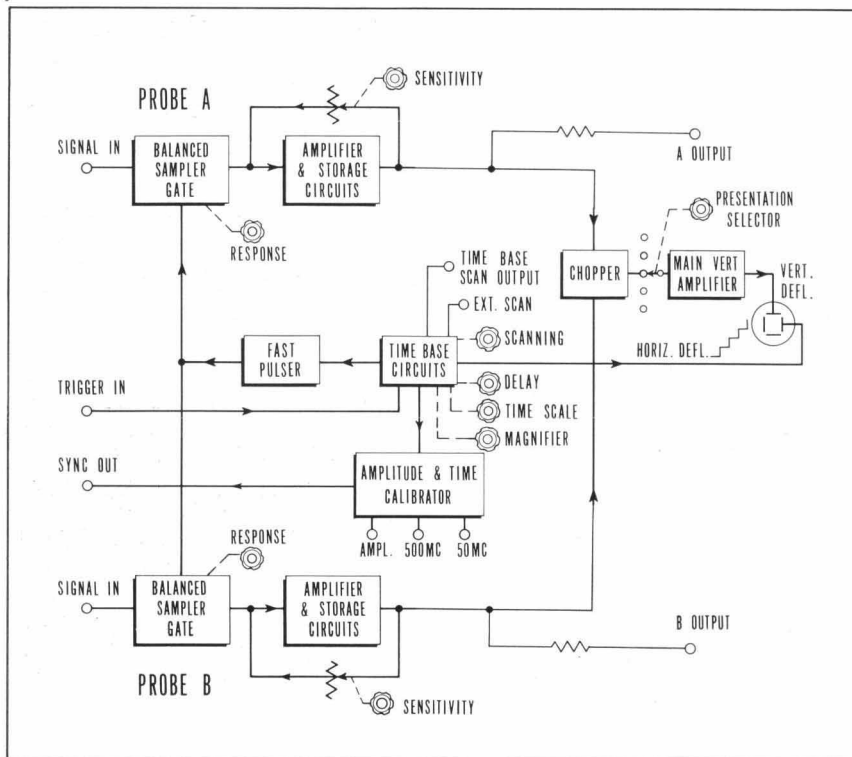

Fig. 7. Basic circuit arrangement of hp-Model 185A/187A Oscilloscope.

matched diodes in a balanced arrangement whose bridge action reduces the effect of noise produced in the switch and gives the instrument a low noise level. The arrangement also minimizes the amount of switching pulse introduced into the measured circuit. Although this pulse would produce no error in the observed waveform, as a spurious pulse it would be undesirable in the measured system.

The sampling system has further been designed to give the instrument the very desirable property that its voltage accuracy is independent of the efficiency of the sampling process. More specifically, the voltage accuracy is independent of the characteristics of the sampling diodes, of the preamplifiers in the system, and, of particular importance, of the characteristics of the sub-millisecond switching pulse, since in the present state of the art pulses of this speed do not have high stability with changes in temperature and time.

The independence from variations in the sampling switch characteristics has been obtained by enhancing the basic sampling circuitry with a feedback arrangement new to the sampling oscilloscope field. The net effect of this feedback can be determined from the basic circuit form indicated in Fig. 5. In this circuit the signal sample initially stored on the input capacity of the cathode follower is amplified and stored in a

second storage circuit. The level in this second storage circuit is then compared with the signal itself by means of the feedback circuit and switch. If the stored level is not equal to the signal amplitude, an error signal will be applied to the system input during the moment of the next sample. The arrangement is such that the feedback signal and thus the signal in the second storage circuit will be brought into amplitude equality with the signal being measured through a nulling process. Because of this process, switching pulse, diode, and preamplification variations are removed as factors in the accuracy of the observation.

The feedback arrangement also gives a number of other advantages for the instrument including the wide dynamic range of the sampler. This occurs because only *changes* in the signal amplitude cause charge to be drawn through the sampling switch. The switch can thus sample large signals up to the value set by the reverse bias on the switch. This value is ± 2 volts, enabling large signals to be observed directly and giving the unit a dynamic range of about 1000:1, since the unit's noise level is 2 mv or less.

As further consequences of the fact that the feedback arrangement causes current to be drawn only on changes in the value of the observed signal, the sampler presents much less disturbance

to the measured circuit than would a simple sampler and, further, a substantially smaller blocking capacitor than otherwise can be used at the sampler input when ac coupling is desired.

LOOP GAIN OPTIMIZATION

The foregoing indicates how the feedback in the sampling system corrects an inaccurate sample for the case where the sample-to-sample amplitude change in the measured signal is slight. This case is probably the general case, because the sampling density of 100 samples per centimeter is sufficient that the sample-to-sample change in the signal will normally be small for all but cases where a reduced sampling density may be used, as described later. Typical displays where the sample-to-sample change is small are those where the trace appears essentially continuous, as in Figs. 2, 8, and others.

For the case where a reduced sampling density may be used or for other possibilities where the signal is displayed by few samples such as the initial rise of the lower trace of Fig. 9, it is desirable that *each* sample be an entirely accurate sample, since otherwise the displayed rise of the signal will be erroneously lengthened.

To make the oscilloscope capable of making each sample an accurate sample regardless of scan density, the loop gain in the sampling system has been optimized to unity. For the loop consisting of the sampling and feedback circuits indicated in Fig. 5, it will be evident that unity loop gain causes each sample that the instrument makes to be an accurate sample, because any inefficiencies in the sampling portion of the loop are overcome by the amplification in the loop. Hence, optimum loop gain makes the display accuracy totally independent of sampling density. Further, the display will follow waveforms

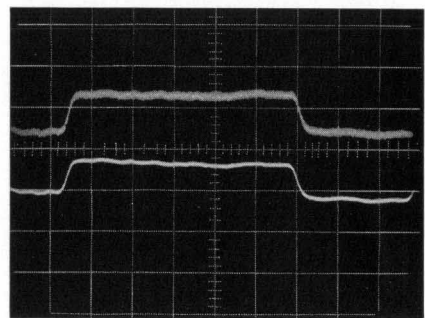

Fig. 8. Double-exposure type oscillogram illustrating a 3 millivolt pulse with no smoothing (upper trace) and using smoothing feature (lower trace) to improve new oscilloscope's already small 2 millivolt rated noise value. External circuit random noise will be similarly improved by smoothing feature.

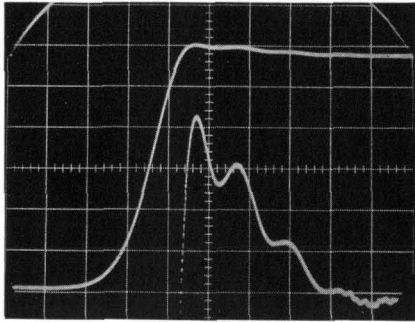

Fig. 9. New Oscilloscope has unusual property of not overloading, as indicated by lower trace in this oscillogram which is same as upper trace except at 20 times as much sensitivity. See text for details.

that are not uniform from cycle to cycle. Oscillation by the system is prevented by suitably synchronized gating in the loop.

EXTERNAL AND INTERNAL NOISE REDUCTION

Despite the fact that it is generally advantageous for the sampling system to have optimum loop gain, there are special situations where less than optimum loop gain can be employed to special advantage.

As described previously, a less than optimum value of loop gain will cause the sampling system to require more than one sample to build the displayed signal to proper amplitude. Now for cases in which the signal has random noise or jitter, reduced loop gain will act to reduce the apparent amount of such noise and jitter, since these can be considered to be signals that are not uniform from cycle to cycle. In other words reduced loop gain will actually cause the sampling system to discriminate against random noise and jitter in the display of the signal while having no effect on the signal itself, unless it is displayed by few samples. Similarly, the apparent noise level of the sampling circuit itself can be reduced by using less than optimum loop gain.

To permit a reduced loop gain to be used to advantage in measurements, a *Normal - Smoothed* switch is provided on the panel. In the *Normal* position the loop gain has its optimum value, while in the *Smoothed* position the loop gain is reduced such that random noise and jitter in the external signal will be reduced in the display by a factor of 3. The rated 2 millivolt noise level of the oscilloscope will also be reduced by this same factor to below 1 millivolt, and the rated 0.10 millimicrosecond jitter in the sampling will be reduced to below 0.05 millimicrosecond. The effect

of smoothing on a sensitive display is shown in Fig. 8.

NON-OVERLOAD CHARACTERISTIC

An especially useful property of the sampling system used in the instrument is that it does not suffer the large-signal overload problem that is characteristic of conventional oscilloscopes. The reason for this is that the sampling system has the relatively long interval between samples to recover from overloads. As a result the oscilloscope can display small-amplitude phenomena existing along the top or bottom of large signals, as indicated in Fig. 9. Here, the upper trace shows a pulse displayed by one channel of the instrument using minimum sensitivity (200 mv/cm). The lower trace shows the detail at the top of the same pulse as displayed by the second channel using 20 times as much sensitivity (10 mv/cm). Ringing and overshoot on the large pulse can thus be examined in detail.

The non-overload property applies for signals up to the value that overcomes the reverse bias in the sampling system and thus disrupts the sampling process. This level is 2 volts.

SYNCHRONIZED DUAL CHANNELS

The dual channel capability in the new oscilloscope has been obtained by using two independent sampling channels which sample their respective inputs simultaneously. The input of the main vertical amplifier is then electronically switched between the two channels at a rate high enough to display the outputs of both channels on each sampling.

In fast-circuit work the dual presentation capability has proved very valuable, and considerable care has been taken to achieve close synchronization between the two channels. Time delay error between channels has been minimized by making both samplers operate at very nearly the same time. The pulses which close the diode samplers are generated in a fast pulse generator which is common to both channels, while physical layout and cables to the sampling probes have been made essentially identical. These measures have resulted in a time delay error between channels that is less than 0.10 mμsecond—i.e., the time required for light to travel approximately 1 inch. If desired, even this slight difference can be largely corrected by connecting both probes to the same fast signal and determining the proper correction factor from the resulting display.

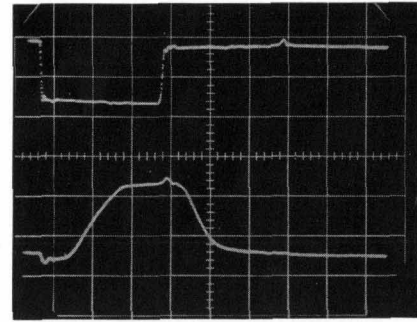

(a)

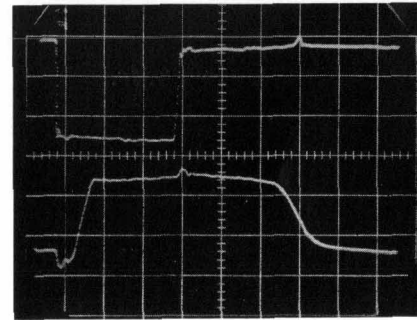

(b)

Fig. 10. Oscillograms showing fast switching pulse (upper traces) with resulting mesa transistor output waveform for two degrees of saturation. Time scale is 5 millimicroseconds/cm.

FAST-TRANSISTOR RESPONSE-TIME MEASUREMENTS

The close synchronization between channels coupled with the fast time scales of up to 0.1 mμsecond/cm enable fast-circuit time relationships and very small time differences in external signals to be measured. Fig. 10, for example, suggests how readily response-time measurements can be made on transistors. The waveforms shown are from a fast mesa transistor operating in the common-emitter test circuit of Fig. 11. Initially, the transistor is biased off and is turned on by a fast current pulse. The resulting transistor operation for two degrees of saturation is shown in Fig. 10.

Another measurement facilitated by the dual presentation feature is circuit delay. An interesting example of this type of measurement is demonstrated by the oscillograms of Fig. 12 which show the delay in the *hp*-Model 355B DC - 500 megacycle coaxial attenuator at 0 and 20 db of attenuation. A test pulse derived from an avalanche transistor was passed through the attenuator while the input and output were monitored by the oscilloscope using a 1 mμsecond/cm sweep. Note that one signal in Fig. 12 (c) is 20 db below the other; i.e., delay measurements can be

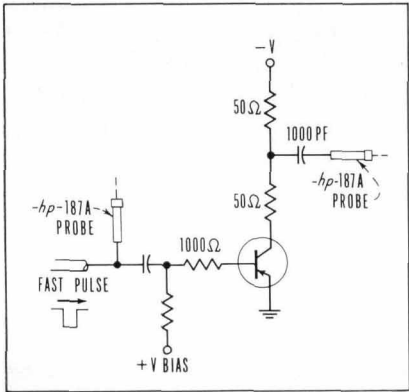

Fig. 11. Test circuit used in making oscillograms in Fig. 10.

made of two signals widely different in amplitude.

EXTERNAL TRIGGER ALTERNATIVES

In the design of conventional oscilloscopes it is customary to arrange for the signal being viewed to be delayed before being applied to the vertical deflection system. This delay permits the sweep circuits to become properly operative before displaying the signal. In the sampling oscilloscope, however, the "sweep" circuits serve a different-from-usual purpose in that they produce a pulse which is applied to the sampling switch directly at the vertical input terminal. Any inserted delay must therefore precede the sampling switch, but to insert delay at that point would give the oscilloscope the low impedance of a delay line as its input impedance rather than the high impedance that the balanced sampling switch has achieved. Consequently, other arrangements for achieving the required time-spacing between trigger and signal have been provided.

One arrangement is provided in the form of a special sync out pulse. This pulse is arranged to trail a trigger-in pulse by the 100 or so millimicroseconds needed for the sweep circuits to operate and produce the sampling pulse which samples the signal. This sync out pulse thus has the proper delay incorporated in it and can be used to trigger an external circuit under test. The sync out pulse has an amplitude of -1.5 volts and a rise time of 4 millimicroseconds. It is available both when the sweep circuit is free-running and when it is triggered. In the free-running mode the pulse has a 100 kc repetition rate, but in the triggered condition it occurs at the rate dictated by the external trigger. In each case this corresponds to the sampling rate of the oscilloscope.

A second alternative is to insert the

necessary delay between an external trigger and the circuit it is triggering by means of a delay line. Such an external line is available as an accessory for the oscilloscope. It consists of an appropriate length of 50-ohm coaxial line housed in a convenient case, as indicated in Fig. 13. An adapter is also available (Fig. 18) to permit the trigger to be taken off ahead of the line to trigger the oscilloscope.

If the signal is in a coaxial circuit or if the signal must also serve as the trigger, the take-off adapter and delay line can also be used ahead of the signal input on the oscilloscope to delay the signal.

Other alternatives for achieving the needed lead-time in the trigger include selecting a trigger from an appropriately early stage in the external circuit. Excessive external trigger lead-time can be compensated for with instrument's delay control. When high-repetition rate signals of a megacycle or more are being studied, it is also often practical to use the oscilloscope's delay control to view the signal that follows the one that actually triggers the oscilloscope.

SCANNING OF LOW REPETITION-RATE SIGNALS

When a conventional oscilloscope is used to view a fast signal of low repetition rate, the trace becomes dim, frequently so much so that the presentation is no longer visible. The sampling oscilloscope, however, does not suffer this disadvantage. Its trace is as bright with a fast, low-rate signal as with any other, giving the instrument a tremendous advantage in fast-signal work. Low repetition rates do cause the beam to move more slowly than higher-rate signals because of the time needed to obtain the 1,000 samples that comprise the normal sweep, but this can be offset by reducing the number of samples taken per trace at some expense in resolution. The scan control on the oscilloscope is thus arranged to offer a choice

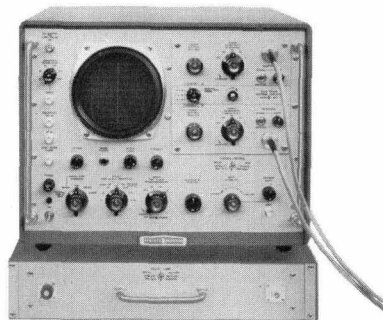
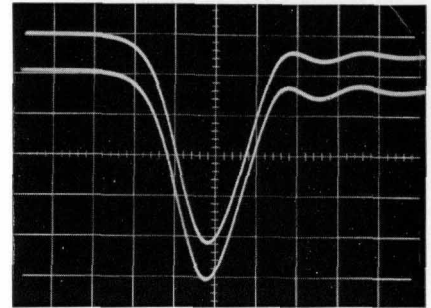
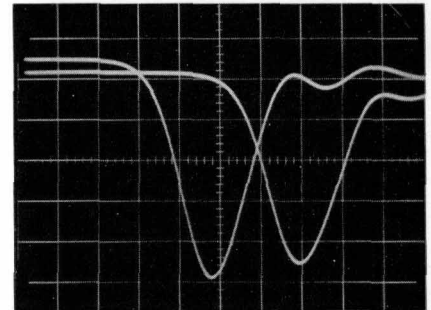

Fig. 13. -hp AC-16V Delay Line can be used to delay triggering of external circuit or to delay signal, is arranged to fit out of the way under oscilloscope.



(a)



(b)

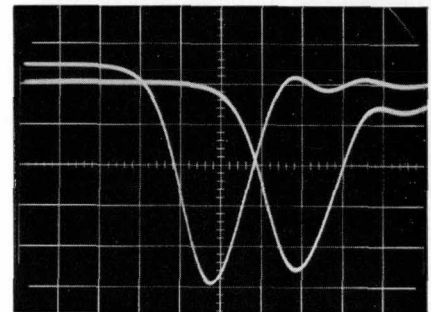

(c)

Fig. 12. Oscillograms made from new oscilloscope demonstrating how readily time delay measurements can be made. Time scale is 1 μ sec/cm. (a) shows fast pulse at input to test device (-hp-355B coaxial attenuator) as displayed by both oscilloscope channels; (b) compares pulse at attenuator input with same pulse at output for zero setting of attenuator; (c) same as (b) except attenuator set for 20 db and oscilloscope sensitivity increased correspondingly.

of 50 or 200 (Coarse or Medium) samples per trace in addition to 1,000. This permits signals with repetition frequencies usually well below 50 pps to be observed. Lower rates can be observed by making a time-exposure photograph of the display or by making an external X-Y recording, as noted elsewhere herein. Fig. 14 demonstrates the change in resolution offered by the three sampling rates.

TIME BASE AND MAGNIFICATION

Despite the unconventional nature of the sweep employed in the sampling

PERMANENT X-Y RECORDINGS OF DISPLAYED SIGNALS

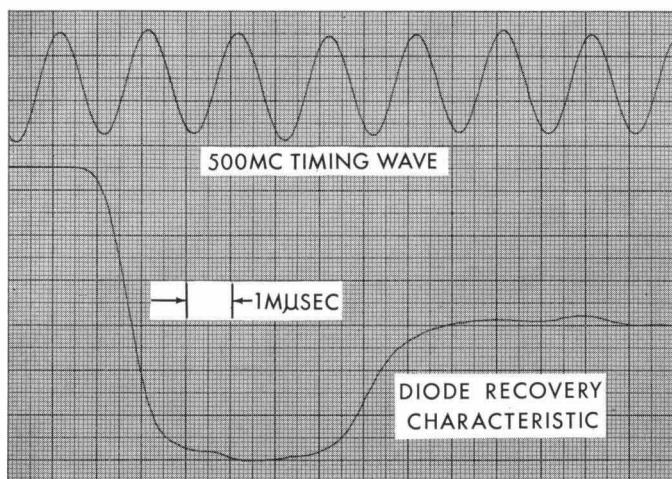

As described in the accompanying article, horizontal deflection in the new oscilloscope is accomplished by a staircase waveform whose steps are synchronized with the pulses that sample the signal being observed. In addition to this automatic scanning, however, provision is also made for scanning to be manually controlled by the operator. Under this arrangement, scanning occurs in proportion to the rotation of a panel control (*Scanning - Manual*). Combined with this manual scanning provision,

an output from each of the vertical signal channels in the form of dc voltages proportional to the vertical deflection of the trace is made available at terminals at the back of the instrument. A dc voltage proportional to the horizontal position of the trace is also available at a rear terminal.

The net result of this arrangement is that signal and horizontal deflection voltages in dc form are externally available and can be applied to an X-Y recorder to make permanent

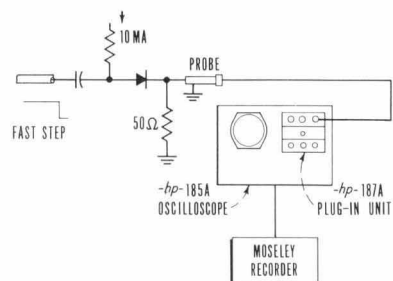

Test circuit used to make accompanying X-Y recording.

recordings of the signal or signals being displayed by the oscilloscope. Plotting is carried out by manually advancing the *Manual Scan* control. Even though the *Manual Scan* control is turned slowly enough to accommodate the recorder, the recording itself will have whatever time base that the controls on the oscilloscope are set to present. The curve reproduced here, for example, shows a very fast time function which was recorded using the outputs provided by the oscilloscope in this manner.

An additional terminal is provided at the back of the oscilloscope to permit scanning by the oscilloscope, and thus the external recording process as well, to be carried out under the control of an external dc voltage.

oscilloscope, the sweep controls are essentially identical to and provide a flexibility equal to that associated with well-equipped conventional oscilloscopes. The controls include a time base magnifier which provides up to x100 magnification. In this sampling oscilloscope magnification has the special characteristics that it causes no dimming of the trace and results in no loss of time base calibration accuracy. Neither does it cause a loss in resolution. The magnifier can be used with the basic time scale control to achieve sweep speeds of up to 0.1 millimicrosecond/cm or with the delay control in delayed-sweep applications. The delay control permits any point on the unmagnified sweep to be chosen for magnified display.

AMPLITUDE AND TIME-BASE CALIBRATORS

In order to provide for maximum convenience in checking the oscilloscope calibration, a two-frequency time-base calibrator is provided in addition to the customary amplitude calibrator. Two terminals are provided at the left side of the panel to make avail-

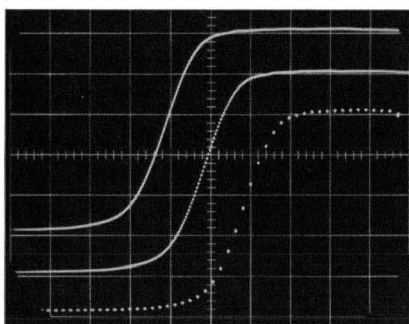

Fig. 14. Sampling density of oscilloscope can be reduced to reduce scan time on low-repetition rate signals. Traces above compare resolution obtained with fine, medium and coarse scanning.

able a 500-megacycle and a 50-megacycle frequency for time-base comparison. These frequencies are accurate within 1% and are obtained by impulse-exciting two tuned circuits in the instrument.

The amplitude calibrator provides a square-wave calibrating waveform of amplitudes equal to the voltage ranges on the vertical channels at a voltage accuracy of within $\pm 3\%$.

PROBES AND ACCESSORIES

The physical arrangement of the signal probes provided on the vertical input channels is portrayed in Fig. 15. To make the probe adaptable to situations requiring minimum lead lengths such as in chassis wiring, the probe is equipped with a ground pin on a sliding type clamp. In cases where the clamp is not needed, such as when one of the adapters is being used, this clamp can be removed or placed at the back portion of the probe.

The adapters designed for use with the probe are shown in Fig. 17 and 18. Adapter (A) in Fig. 17 is the adapter shown being installed in Fig. 16 and changes the probe input to a type BNC male fitting. Adapter (B) changes the probe input to a type N female fitting. Adapter (C) is a divider that provides a 10:1 increase in the amplitude of signals that can be viewed and increases the oscilloscope input impedance to 1 megohm shunted by 3 mmf. Adapter (D) is a 1000-mmf 500-volt capacitor which is installed in place of the probe center pin to obtain ac coupling.

Adapter (E) is designed to permit

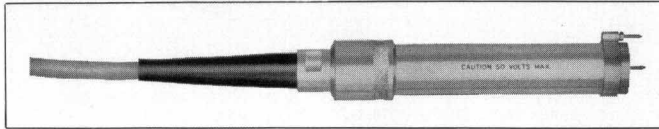

Fig. 15. Physical form of signal probe. Each channel of plug-in unit is equipped with one such probe on five-foot cable.

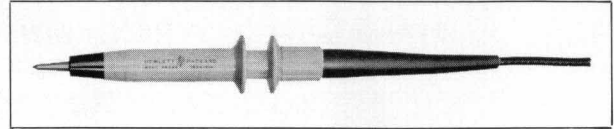

Fig. 19. Sync probe provided on oscilloscope.

the probe to monitor the voltage in a 50-ohm cable. The adapter consists of a 50-ohm T-section with type N connectors which can be connected into a 50-ohm line. The probe then connects to the special fitting at the side of the body of the adapter.

The final adapter (F) is the sync take-off adapter which is used in combination with the AC-16V Delay Line discussed earlier. The adapter gives a 6-db insertion loss for both signal and trigger outputs.

Fig. 19 shows the sync probe supplied with the instrument. The flanges on the probe body open the probe jaws in the manner that has proved popular on other -hp- oscilloscope probes.

OTHER PLUG-INS

Additional plug-in units for the new oscilloscope are in the planning stage. Correspondence concerning special measuring requirements is invited.

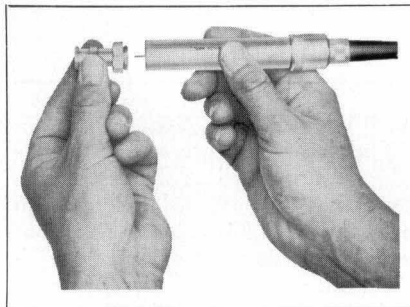

Fig. 16. Adapter being installed to enable signal probe to be connected to BNC type fittings.

ACKNOWLEDGMENT

The design and development of the 185A/187A Oscilloscope was a joint effort of several members of the Oscilloscope Division of the -hp- Research and Development Department. In addition to the undersigned, members of the group were Stewart Krakauer, Kay Magleby, Kenneth Miller, Richard Monnier, Victor Van Duzer, and Richard Woodbury. Valuable ideas and suggestions along the way were given by Bernard M. Oliver and Norman B. Schrock. The mechanical and production aspects of the instrument were ably handled by Charles Fitterer, Wallace Klingman, and Edna MacLean.

—Roderick Carlson

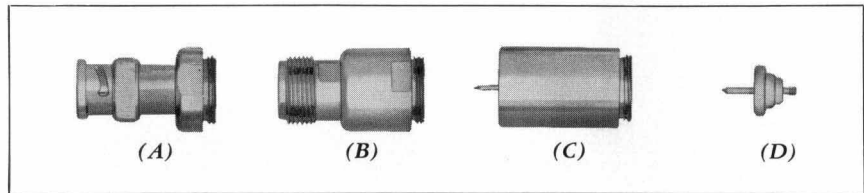

Fig. 17. Adapters available for use with signal probe of Fig. 15.

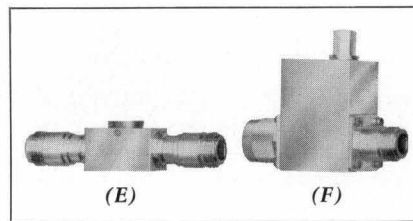

Fig. 18. (right) Sync take-off adapter for use with AC-16V Delay Line of Fig. 13 permits trigger to be obtained for oscilloscope ahead of triggering of external circuit. (left) Adapter to permit oscilloscope signal probe to be connected across 50-ohm cable with type N fittings.

SPECIFICATIONS

-hp- MODEL 187A

DUAL TRACE AMPLIFIER

(When plugged into Model 185A Oscilloscope)

VERTICAL (Dual Channel)

Bandwidth: Greater than 500 mc at 3 db point. Less than 0.7 μ sec rise time.

Sensitivity: Calibrated ranges from 10 mv/cm to 200 mv/cm in a 1, 2, 5 sequence. Vernier control between steps increases sensitivity to 3 mv/cm.

Overshoot or Undershoot: Less than 5%.

Voltage Calibrator: 10 mv to 500 mv; accuracy $\pm 3\%$.

Input: By means of input probe for each channel.

Noise: Less than 2 mv peak-to-peak; reduced by approximately 3:1 in smoothed (noise compensation) position of input switch.

Input Impedance: 100k shunted by 3 μ f.

-hp- MODEL 185A OSCILLOSCOPE

HORIZONTAL

Sweep Speeds: 0.1 μ sec/cm to 100 μ sec/cm. Calibrated within $\pm 5\%$ using any combination of TIME SCALE and TIME SCALE MAGNIFIER settings with the exception of the first 50 μ sec of the 100 μ sec/cm TIME SCALE and first 20 μ sec of the 50 μ sec/cm TIME SCALE.

Time Scale: 4 ranges, 10, 20, 50, and 100 μ sec/cm. Vernier control between steps increases speed.

Time Scale Magnifier: x2, x5, x10, x20, x50, x100; may be used with any time scale setting.

Jitter: Less than 0.1 μ sec peak-to-peak; reduced by approximately 3:1 in smoothed (noise compensation) position of vertical input switch.

Sample Density: Fine (approx. 1000 samples/trace), medium (approx. 200 samples/trace), and coarse (approx. 50 samples/trace).

Manual Scan: Permits making X-Y pen-recordings.

Time Calibrator: 500 mc and 50 mc damped sine waves (frequency accuracy $\pm 1\%$).

Minimum Delay: Less than 120 μ sec.

Variable Delay Range: Ten times the TIME SCALE setting less the display time. (Applies only when TIME SCALE is magnified.)

External Trigger: ± 50 mv for 20 μ sec or longer, ± 0.5 volt for 1 μ sec; approximately 120 μ sec in advance of signal to be observed.

"Sampling" Repetition Rate: 100 kc maximum. Trigger Rate: 50 cps to at least 50 mc (holdoff circuit in operation above 100 kc).

Trigger Input Impedance: With Sync Probe, greater than 500 ohms; without probe, 50 ohms at panel. Capacitive coupling.

SYNC PULSE OUTPUT

Amplitude: Negative 1.5 volts into 50 ohms.

Rise Time: Approximately 4 μ sec.

Timing: Approximately 20 μ sec after the start of undelayed trace.

Repetition Rate: Approximately 100 kc, or the rate may be controlled by a fast-rise generator.

GENERAL

X-Y Recorder Output: Available in MANUAL SCAN for making pen-recording of waveforms: Horizontal Output: Zero at left to approximately 12 volts at right of CRT face; source impedance 2,000 ohms. Vertical Output: -1 volt at bottom to +1 volt at top of CRT face; source impedance 10,000 ohms.

Beam Finder: Facilitates location of beam that is off scale vertically or horizontally.

Cathode Ray Tube: 5 in. type 5AQP1.

Useful Deflection: 10 cm x 10 cm.

Power: 115/230 volts $\pm 10\%$, 50 to 60 cps; approximately 250 watts.

Dimensions: Cabinet Mount: 14 $\frac{5}{8}$ in. high, 19 in. wide, 22 $\frac{1}{8}$ in. deep. Rack Mount: 12 $\frac{1}{4}$ in. high, 19 in. wide, 21 in. deep behind panel.

Weight: Net 75 lbs.

Accessories Furnished: 187A-76A BNC Adapter, 2 supplied. 185A-21A Sync Probe.

Accessories Available: 187A-76B Type N Adapter, 187A-76C 10:1 Divider, 187A-76D Blocking Capacitor, 187A-76E 50 ohm T Connector, 187A-76A Sync Take-off Adapter, AC-16V 120 μ sec Delay Line.

Price: -hp- Model 185A Oscilloscope, Cabinet Mount, \$2,000.00. -hp- Model 187A Dual Trace Vertical Amplifier, \$1,000.00.

Prices f. o. b. Palo Alto, California
Data subject to change without notice.